

# LED strip and LED driver removal instruction manual

TURN OFF ELECTRICITY SUPPLY BEFORE WORK IS CARRIED OUT

Open the backboard or electrical box firstly:

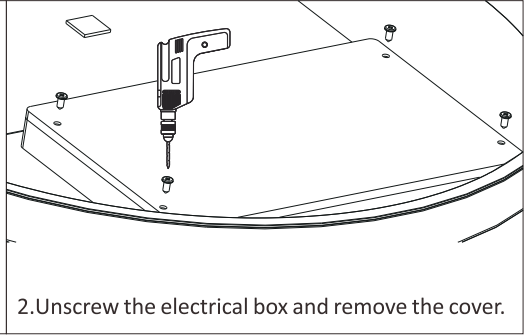
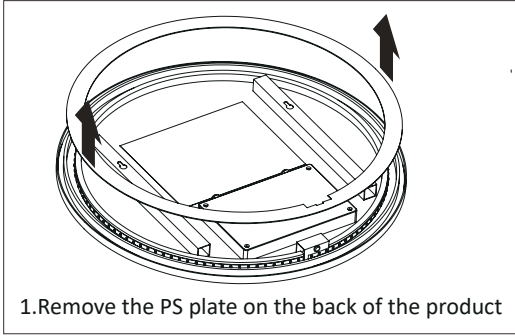

LED strip removal step:

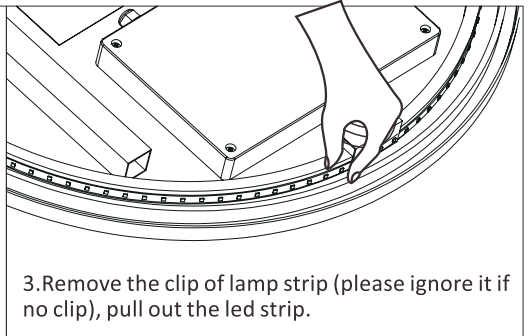
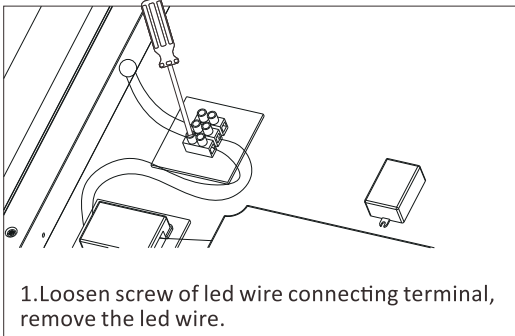

## LED driver removal step:

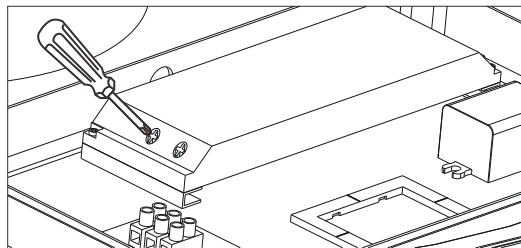

1. Unscrew both ends of the led driver cover.

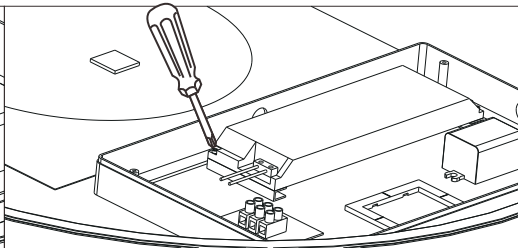

2. Remove the led driver cover, loosen screw of both led driver terminals.

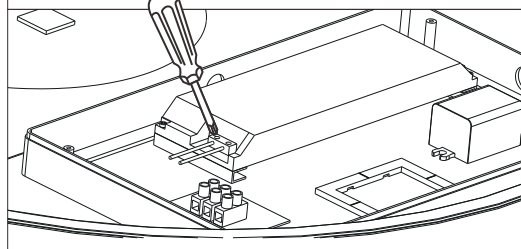

3. Remove the wires at both ends of the led driver, Unscrew the led driver base.

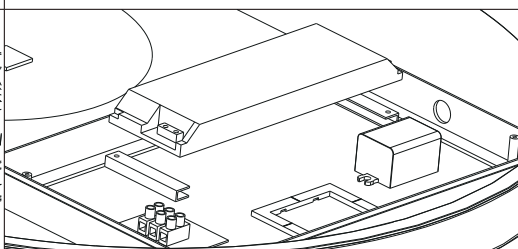

4. Remove the led driver.

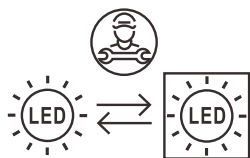

Replaceable (LED only)  
light source by a professional

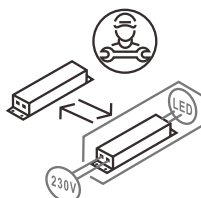

Replaceable control gear  
by a professional

This product contains a light source of energy efficiency class 'E'

The pictograms are available in .jpg and .eps format through the following link: